

# GREYSTONE ENERGY SYSTEMS INC

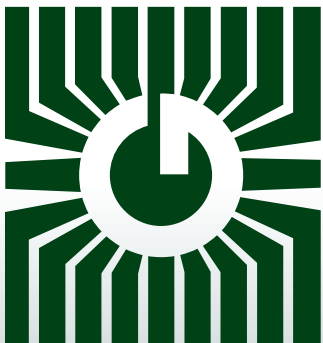

## PROBE TEMPERATURE TRANSMITTERS TE500 Series



### Precision temperature control/sensing

#### FEATURES:

- Precision RTD sensing element
- Choice of scaled ranges and outputs
- Various enclosure styles
- Various configurations
- Custom laser etching available

*Peace of mind  
through reliable  
temperature monitoring*

GREYSTONE HAS AN ISO 9001 REGISTERED QUALITY SYSTEM

# TE500 - TEMPERATURE TRANSMITTER CONFIGURATIONS

## FEATURES:

The TE500 temperature transmitters offer a platinum RTD's with transmitter which can be interfaced with a computerized monitoring or control system. A wide variety of configurations are available such as:

**B) Duct Sensor** – The B is for single point monitoring. It comes with a stainless steel probe which is available with various probe lengths and enclosures.

B)



**C) Immersion Sensor** – The C comes in two configurations. It has either spring loaded or non-spring loaded probes and has a 1/2" NPT fitting to be mounted into a thermowell. It is available in various lengths and enclosures.

C)



**FD, D, DC & DR) Duct Averaging Sensor** – The D, DR & FD models incorporate numerous sensors along the assembly and act as a single sensor averaging the temperature across the sensors. The DC is a continuous sensing element that senses a temperature change along the entire probe length. They are available in various lengths. The FD probe is constructed of FT-6 rated plenum cable which allows for easy installation. The D & DC probes are constructed of bendable soft copper and the DR is a constructed of rigid stainless steel. Various enclosures are available.

FD)



D & DC)



DR)



**E) & ES) Strap-on Sensor** – The E comes with stainless steel probe and is available in several lengths and 1.5 m (5') of zip cable for remote mounting. The ES has an aluminum plate with an expandable 10" clamp assembly to strap directly to a pipe. Various enclosures are available.

E)



ES)



**F) OSA Sensor** – The F comes in a hinged weatherproof ABS enclosure and incorporates a sun/wind shield to protect the sensor.

F)



**FL) Flying Lead** – The FL comes with a 2" stainless steel probe and 1.8 m (6') of FT6 plenum rated cable for remote mounting. Various enclosures are available.

FL)



**G) Glass** – The sensor is encapsulated in a 1/2" square x 2" aluminum wafer that can be affixed to any surface. It comes with 5' of zip cable and various enclosures are available.

G)



**H) Stack** – Is designed for installation in an exhaust stack to measure flue gas temperature. Comes standard with a mounting flange and weatherproof enclosure

H)

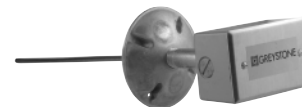

## SPECIFICATIONS:

Sensor.....	<b>Type 2</b> -100 Ω Platinum, IEC 751, 385 Alpha, thin film <b>Type 12</b> - 1000 Ω Platinum, IEC 751, 385 Alpha, thin film ( <b>Standard</b> ) <b>*Type 4</b> - 100 Ω Platinum, IEC 751, 385 Alpha, wire wound <b>*Type 28</b> - 1000 Ω Platinum, IEC 751, 385 Alpha, wire wound ( <b>Standard</b> ) <b>*Must use for applications above 400°C (752°F)</b>
Sensor Accuracy .....	±0.3°C (±0.54°F) @ 0°C (32°F)
Transmitter Output Signal .....	4-20mA current loop, 0-5 vdc, or 0-10 Vdc (factory configured)
Transmitter Accuracy .....	±0.1% of span, including linearity
4-20 mA loop Power Supply ...	15-35 Vdc or 22-32 Vac
Minimum Loop Current .....	2 mA nominal (occurs with shorted sensor)
Maximum Loop Current .....	22.5 mA nominal (occurs with open sensor)
Maximum Loop Load .....	>600 ohms
0-5 Vdc Power Supply .....	10-35 Vdc or 10-32 Vac
0-10 Vdc Power Supply .....	15-35 Vdc or 15-32 Vac
Maximum Current (Voltage) ...	5 mA nominal
Maximum Output (Voltage) ....	Limited to <5.5 Vdc for 0-5 Vdc, <10.5 for 0-10 vdc
Input Voltage Effect .....	Negligible over specified operating range
RFI rejection .....	Good RFI rejection of normal frequencies with standard installation
Protection Circuitry .....	Reverse voltage protected and output limited
Probe Sensing Range .....	<b>B, C, E, ES &amp; G:</b> -20 - 105°C (-4 - 221°F) <b>D, DR &amp; FD:</b> -20 - 60°C (-4 - 140°F) <b>DC:</b> -40 - 100°C (-40 - 212°F) <b>F:</b> -40 - 85°C (-40 - 185°F) <b>H:</b> -100 - 600°C (-148 - 1112°F)
Ambient Operating Range .....	-40 - 85°C (-40 - 185°F)
Operating Humidity .....	0-95% RH non-condensing
Probe Material .....	<b>B, C, DR, E, FL &amp; H:</b> 6.35 mm (0.25") O.D., 304 series stainless steel <b>D &amp; DC:</b> 7.94 mm (0.3125") O.D. soft copper <b>FD:</b> FT-6 rated plenum cable <b>ES:</b> 2" x 2" aluminum plate <b>G:</b> 0.5" x 0.5" x 2" aluminum wafer
Wire Material .....	<b>B, C, DR, E, ES &amp; G:</b> PVC insulated, parallel bonded, 22 AWG <b>D, FD &amp; FL:</b> FT-6 rated plenum cable, 22 AWG <b>DC:</b> PTFE insulated, 22 AWG <b>H:</b> Fiberglass insulated, 24 AWG
Enclosure .....	Standard - ABS - UL94-5VB - IP61 (NEMA2) Round ( <b>E</b> ) - ABS - UL94-5VB - IP65 (NEMA 4X) Metal ( <b>M</b> ) - Galvanized Steel - IP50 (NEMA 1) Weatherproof ( <b>W</b> ) - Cast Aluminum - IP64 (NEMA 3X) Hinged Weatherproof ( <b>F</b> ) - ABS UL94-5VB - IP65 (NEMA 4X)
Wiring Connections .....	Screw terminal block (14 to 22 AWG)

## THERMOWELLS:



NOTE:

6" and up machined thermowells have a two step stem as shown. welded construction have a 9.5 mm (0.375") diameter

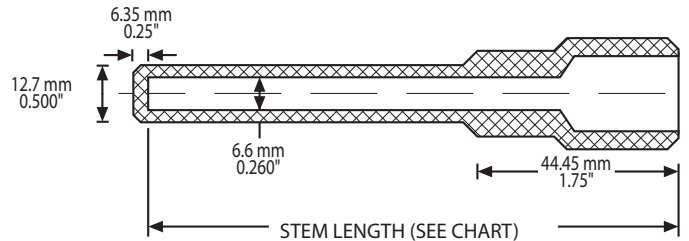
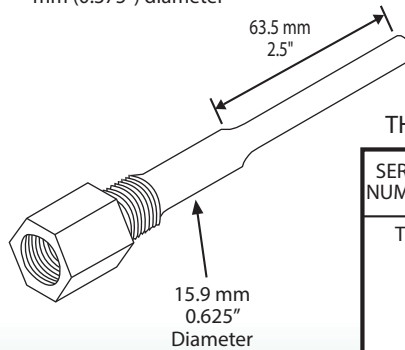
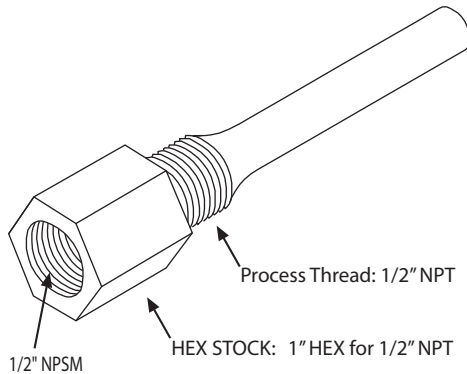

### THERMOWELL PART NUMBERING SYSTEM

SERIES NUMBER	NPT THREAD SIZE	MATERIAL	STEM LENGTH	CONSTRUCTION
T1	1/2"	P - 304 SS R - 316 SS	2" 4" 6" 8" 12" 18"	- MACHINED W - WELDED (12" and up only)

EXAMPLE: T1 1/2 P 4  
4" 304 STAINLESS THERMOWELL  
WITH 1/2" NPT PROCESS THREAD

# PRODUCT ORDERING INFORMATION:

MODEL	Product Description
TE500	Temperature Transmitter Series

CODE	Style
B	Duct mount
C	Immersion
D	Duct average, flexible copper probe
DC	Duct average continuous, flexible copper probe
DR	Duct average, rigid stainless steel probe
E	Strap-on - 50 mm (2") probe assembly
ES	Strap-on - Assembly clamps around pipe with copper plate c/w 254 mm (10") stainless clamp
F	O.S.A. (Hinged ABS enclosure)
FD	Duct average, flexible plenum rated cable
FL	Flying lead
G	Glass
H	Stack <b>(Requires sensor code 4 or 28)</b>

CODE	Enclosure (N/A for F or H)	CODE	Flex Duct Only (FD)
-	ABS enclosure, standard (no code required, leave blank)	B	ABS enclosure
E	Round ABS, w/ gasketed cover	C	Aluminum weatherproof box
M	Metal utility box	D	Metal utility box
W	Aluminum weatherproof box	E	Round ABS, w/ gasketed cover

CODE	Sensor (Type 12 is standard)
2	100 Ω Platinum, IEC 751, 385 Alpha, thin film
12	1000 Ω Platinum, IEC 751, 385 Alpha, thin film <b>(Standard)</b>
4	100 Ω Platinum, IEC 751, 385 Alpha, wire wound * <b>H Mounting Style (See below)</b>
28	1000 Ω Platinum, IEC 751, 385 Alpha, wire wound <b>(Standard) * H Mounting Style (See below)</b>

CODE	Probe Length (B, C, E, & H)	CODE	Averaging (D, DC & DR)	CODE	Flex Duct Only (FD)
A2	50 mm (2")	G3	1800 mm (6')-D/DC	A	1800 mm (6')
B2	100 mm (4")	H3	3600 mm (12')-D	B	3600 mm (12')
C2	150 mm (6")	I3	6100 mm (20')-D/DC	C	6100 mm (20')
D2	200 mm (8")	J3	7300 mm (24')-D	D	7300 mm (24')
E2	300 mm (12")	K2	450 mm (18")-DR		
F2	450 mm (18")	L2	600 mm (24")-DR		
		M2	900 mm (36")-DR		

CODE	Fitting (only required for immersion "C")
A	Spring loaded 1/2" NPT
E	Non-spring loaded 1/2" NPT

CODE	Output Options
1A	4-20mA 2 or 3 wire
1D	0-5 VDC 3 wire
1E	0-10 VDC 3 wire

CODE	Transmitter Scaled Range
1	0°C - 35°C (32°F - 95°F)
2	0°C - 50°C (32°F - 122°F)
3	0°C - 100°C (32°F - 212°F)
4	50°C - 150°C (122°F - 302°F)
5	50°C - 250°C (122°F - 482°F)
6	-50°C - 50°C (-58°F - 122°F)

Custom ranges available upon request

TE500	B	-	12	E2	-	1A	2
-------	---	---	----	----	---	----	---

Greystone Energy Systems, Inc. reserves the right to make design modifications without prior notice.

**EXAMPLE:** Duct temperature transmitter, c/w 1000Ω RTD, 12" S/S Probe, ABS enclosure, 4-20mA output with a 0°C-50°C (32°F-122°F) range.

\* must use for high temperature applications over 400°C (752°F)

# ENCLOSURE DIMENSIONS:

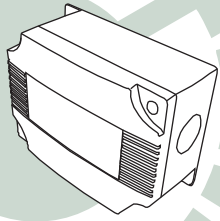

**ABS Enclosure**

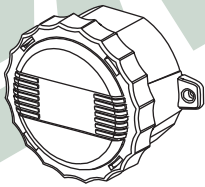
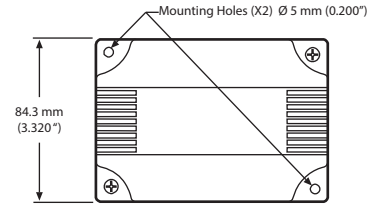
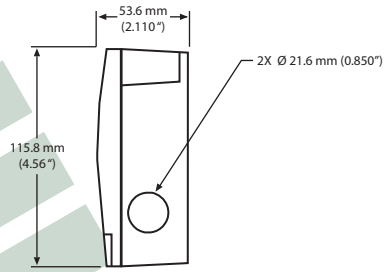

**Round ABS Enclosure (E)**

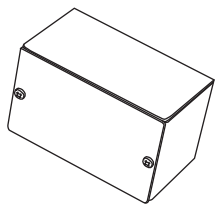
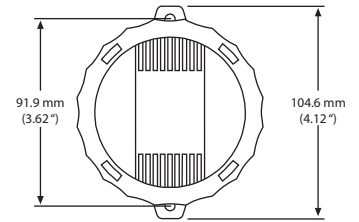
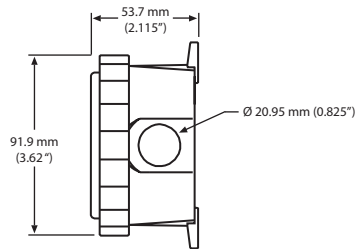

**Metal Enclosure (M)**

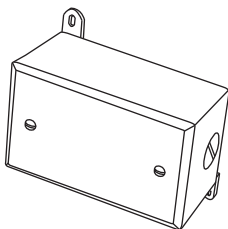
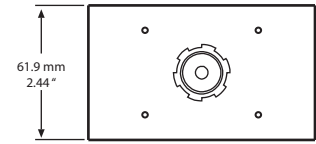
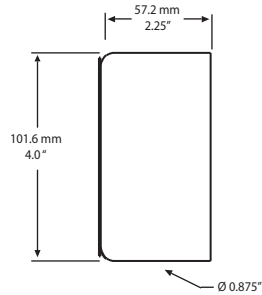

**Weatherproof Enclosure (W)**

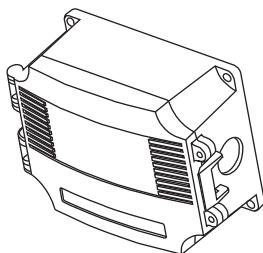
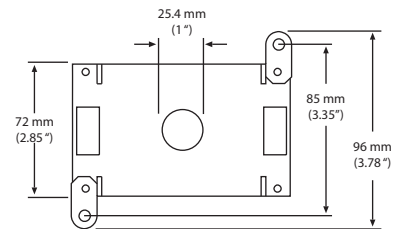
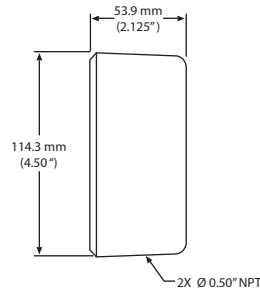

**ABS Hinged Weatherproof Enclosure (F Series Outside Air)**

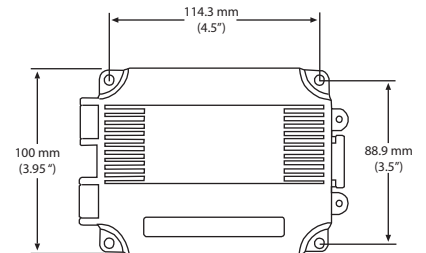
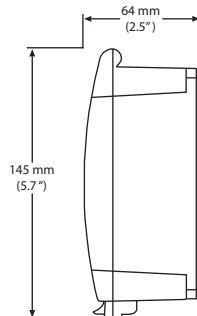

## ACCESSORIES:



**120-\*) Thermal Compound** – The 120- Thermal Conducting Compound is a zinc oxide-filled, dielectric, silicone oil-based compound that facilitates heat transfer by filling voids and gaps between mating surfaces. The operating temperature range is -40° to 200°C (-40° to 392°F). It is available in a 5 oz tube or 2 & 8 oz jars.



**DC-01) Duct collar** - The DC-01 is an adjustable collar for mounting the duct temperature sensor probes. It incorporates a foam backed mounting flange with 2 mounting holes. A compression type fitting accommodates a 1/4" probe and allows for an adjustable probe depth.



**CC-1G) Averaging probe clip** – The CC-1G is used to mount averaging sensors in duct applications. It can be used for probe diameters of 1/8", 1/4" and 3/8". The bracket provides support and a smooth arc for direction reversal allowing for criss-crossing the duct. It eliminates kinking of the sensor and damaging the probe.

A fixed 1/4" probe may also be mounted as part of the bracket design using the scored break-off. It is made out of tough UL94V Nylon and limits heat/cold conduction to the probe and has multiple mounting holes to make mounting quick and easy.



**TS17R-\*) Probe clamp** – The TS17R-\* is a zinc plated, rubber coated tube clamp that can be used to secure a temperature probe. It is available in several sizes to fit a wide variety of probes.



# GREYSTONE

ENERGY SYSTEMS INC

Greystone Energy Systems, Inc.  
150 English Drive, Moncton,  
New Brunswick, Canada E1E 4G7

(506) 853-3057 Fax: (506) 853-6014  
North America: 1-800-561-5611  
e-mail: mail@greystoneenergy.com  
www.greystoneenergy.com

RoHS  
COMPLIANT



*Greystone Energy Systems Inc. is one of North America's largest ISO registered manufacturers of HVAC/R sensors and transmitters for Building Automation Management Systems.*

*We have conscientiously established a worldwide reputation as an industry leader by maintaining leading-edge design technology, prompt technical support, and a commitment to on-time deliveries. We take pride in our Quality Management System which is ISO 9001 certified, assuring our customers of consistent product reliability.*

GREYSTONE HAS AN ISO 9001 REGISTERED QUALITY SYSTEM