

# GREYSTONE ENERGY SYSTEMS INC

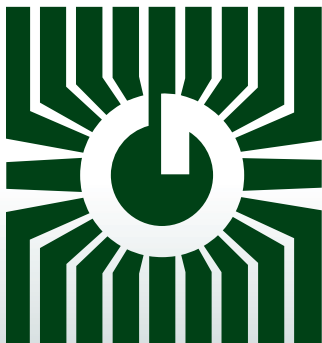

## PROBE TEMPERATURE SENSORS TE200 Series



### Precision temperature control/sensing

#### FEATURES:

- Thermistor or Precision RTD
- Various configurations available
- Selection of enclosures
- Custom laser etching available

*Peace of mind  
through reliable  
temperature monitoring*

GREYSTONE HAS AN ISO 9001 REGISTERED QUALITY SYSTEM

# TE200 - PROBE TEMPERATURE SENSOR CONFIGURATIONS

## FEATURES:

The TE200 temperature sensors offer a choice of precision platinum or nickel RTD's, or NTC Thermistors which can be interfaced with a computerized monitoring or control system. A wide variety of configurations are available such as:

**B & BB) Duct Sensor** – The B & BB is for single point monitoring. Both are available with various probe lengths. The B has various enclosures available and the BB provides a mounting bracket for installation.

B)



BB)



**C & AP) Immersion Sensor** – The C comes in two configurations. It has either spring loaded or non-spring loaded probes and has a 1/2" NPT fitting to be mounted into a thermowell. It is available in various lengths and enclosure styles. The AP is a non-spring loaded probe with a 1/2" NPT fitting to be mounted in a thermowell.

C)



AP)



**FD, D, DC & DR) Duct Averaging Sensor** – All models incorporate numerous sensors along the assembly and act as a single sensor averaging the temperature across the sensors. They are available in various lengths. The FD probe is constructed of FT-6 rated plenum cable which allows for easy installation. The D & DC probes are constructed of bendable soft copper and the DR is a constructed of rigid stainless steel. Various enclosures are available.

FD)



D & DC)



DR)



**E) & ES) Strap-on Sensor** – The E comes with stainless steel probe and is available in several lengths and 1.5 m (5') of cable for remote mounting. The ES has an aluminum plate with an expandable 10" clamp assembly to strap directly to a pipe. Various enclosures are available.

E)



ES)



**F, FE, & FX) OSA Sensor** – Comes in an aluminum LB (F) or ABS (FE/FX) enclosure. The LB is c/w 1/2" NPT fitting for connection to conduit. All incorporate a sun/wind shield to protect the sensor.

F)



FE)



FX)



**G) Glass** – The sensor is encapsulated in a 1/2" square x 2" aluminum wafer that can be affixed to any surface. It comes with 5' of zip cable.

G)



**FL) Flying Lead** – The sensor is encapsulated in a 2" S/S probe with 6' of FT-6 rated cable and can be used in almost any application where temperature monitoring is required.

FL)



**H) Stack** – Is designed for installation in an exhaust stack to measure flue gas temperature. Comes standard with a mounting flange and weatherproof enclosure.

H)

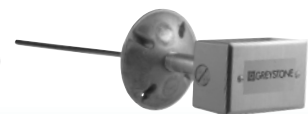

## SPECIFICATIONS:

Sensor.....	Several Thermistors, Platinum or Nickel RTD's available. See product ordering information
Sensor Accuracy .....	<b>Thermistors:</b> $\pm 0.2^{\circ}\text{C}$ ( $\pm 0.36^{\circ}\text{F}$ ), 0 to $70^{\circ}\text{C}$ (32 to $158^{\circ}\text{F}$ ) <b>Platinum RTD's:</b> $\pm 0.3^{\circ}\text{C}$ ( $\pm 0.54^{\circ}\text{F}$ ) @ $0^{\circ}\text{C}$ ( $32^{\circ}\text{F}$ ) <b>Nickel RTD's:</b> $\pm 0.4^{\circ}\text{C}$ ( $\pm 0.72^{\circ}\text{F}$ ) @ $0^{\circ}\text{C}$ ( $32^{\circ}\text{F}$ )
Operating Temperature .....	<b>AP, B, C, E, EX, G, &amp; HC:</b> $-20 - 105^{\circ}\text{C}$ ( $-4 - 221^{\circ}\text{F}$ ) <b>BB, D, DR, FD &amp; FL:</b> $-20 - 60^{\circ}\text{C}$ ( $-4 - 140^{\circ}\text{F}$ ) <b>DC:</b> $-40 - 100^{\circ}\text{C}$ ( $-40 - 212^{\circ}\text{F}$ ) <b>F, FE &amp; FX:</b> $-50 - 100^{\circ}\text{C}$ ( $-58 - 212^{\circ}\text{F}$ ) <b>H:</b> (Sensor 4 & 28) $-100 - 600^{\circ}\text{C}$ ( $-148 - 1112^{\circ}\text{F}$ )
Probe Material .....	<b>AP, B, BB, C, DR, E, FL, H:</b> 6.35 mm (0.25") O.D., 304 series stainless steel <b>D &amp; DC:</b> 7.94 mm (0.3125") O.D. soft copper <b>FD:</b> FT-6 rated plenum cable <b>ES:</b> 2" x 2" aluminum plate <b>G:</b> 0.5" x 0.5" x 2" aluminum wafer
Wire Material .....	<b>AP, B, C, DR, E, ES, G, HC:</b> PVC insulated, parallel bonded, 22 AWG (Sensor type 2, 100 ohm platinum uses FT-4) <b>BB, D, FD, FL:</b> FT-6 rated plenum cable, 22 AWG <b>DC:</b> PTFE insulated, 22 AWG <b>H:</b> Fiberglass insulated cable, 24 AWG
Enclosure .....	Standard - ABS - UL94-5VB - IP61 (NEMA 2) Round (E) - ABS - UL94-5VB - IP65 (NEMA 4X) Metal (M) - Galvanized Steel - IP50 (NEMA 1) Weatherproof (W) - Cast Aluminum - IP64 (NEMA 3X) Hinged Weatherproof (FX) - ABS - UL94-5VB - IP65 (NEMA 4X)
Wiring Connections .....	Pigtail, 2 or 3 wire Round (E) enclosure- screw terminal block (14 to 22 AWG)

## THERMOWELLS:

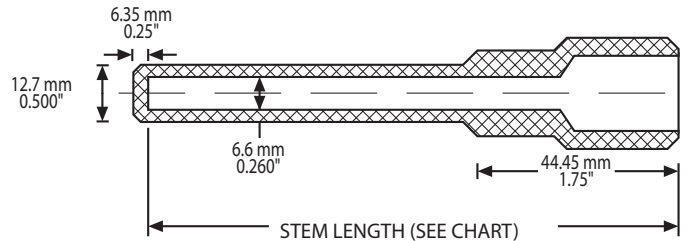

NOTE:

6" and up machined thermowells have a two step stem as shown. welded construction have a 9.5 mm (0.375") diameter

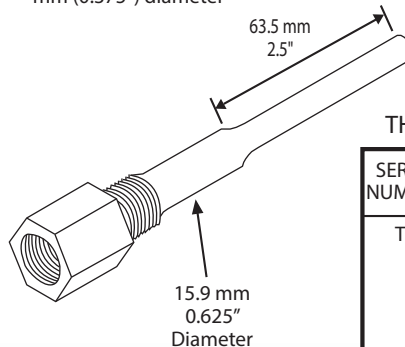
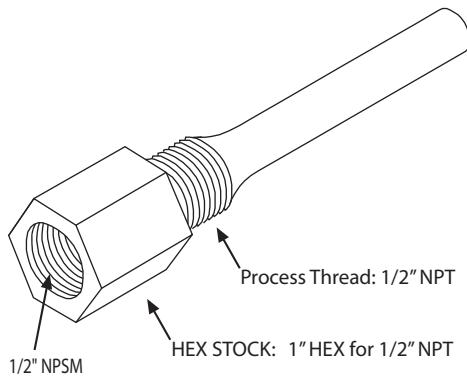

### THERMOWELL PART NUMBERING SYSTEM

SERIES NUMBER	NPT THREAD SIZE	MATERIAL	STEM LENGTH	CONSTRUCTION
T1	1/2"	P - 304 SS R - 316 SS	2" 4" 6" 8" 12" 18"	- MACHINED W - WELDED (12" and up only)

EXAMPLE: T1 1/2 P 4  
4" 304 STAINLESS THERMOWELL  
WITH 1/2" NPT PROCESS THREAD

# PRODUCT ORDERING INFORMATION:

MODEL	Product Description
TE200	Temperature Sensor Series

CODE	Mounting Style
AP	All purpose
B	Duct mount
BB	Duct probe w/ mounting bracket only
C	Immersion
D	Duct average, copper probe
DC	Duct average, continuous copper probe (Available with Type 12, 1000 ohm RTD only)
DR	Duct average, rigid stainless steel probe
E	Strap-on - 50 mm (2") probe assembly
ES	Strap-on - Assembly clamps around pipe with aluminum plate c/w 254 mm (10") stainless clamp
F	O.S.A. , LB fitting
FE	O.S.A. , Round ABS, w/ gasketed cover
FD	Duct average, Flexible plenum rated cable probe
FL	Flying lead
FX	O.S.A. , Hinged ABS enclosure
G	Glass
H	Stack (Only available with Platinum RTD sensor types 4 & 28)
HC	Sensor with mounting clip

CODE	Enclosure (N/A for AP, BB, F, FD, FE, FL, FX, H & HC)	CODE	Flex Duct Only (FD)
-	ABS enclosure, standard (no code required, leave blank)	A	Lead only, no box
E	Round ABS, w/gasketed cover	B	ABS enclosure
M	Metal utility box	C	Aluminum weatherproof
W	Aluminum weatherproof box	D	Metal utility box
		E	Round ABS w/ Gasketed cover

CODE	Sensor
2	100 Ω Platinum, IEC 751, 385 Alpha, thin film
4	100 Ω Platinum, IEC 751, 385 Alpha, wire wound-ceramic* <b>H Mounting Style (see below)</b>
5	1801 Ω, NTC Thermistor, ±0.2 C
6	3000 Ω, NTC Thermistor, ±0.2 C
7	10,000 Ω, Type 3, NTC Thermistor, ±0.2 C
8	2.252K Ω, NTC Thermistor, ±0.2 C
12	1000 Ω Platinum, IEC 751, 385 Alpha, thin film
13	1000 Ω Nickel, Class B, DIN 43760
14	10,000 Ω, Type 3, NTC Thermistor, ±0.2 C c/w 11K shunt resistor
20	20,000 Ω, NTC Thermistor, ±0.2 C
24	10,000 Ω, Type 2, NTC Thermistor, ±0.2 C
28	1000 Ω Platinum, IEC 751, 385 Alpha, wire wound-ceramic* <b>H Mounting Style (see below)</b>

CODE	Probe Length (B, BB, C, E & H)	CODE	Averaging (D, DC, & DR)	CODE	Flex Duct Only (FD)
A2	50 mm (2")	G3	1800 mm (6') - D & DC	A	1800 mm (6')
B2	100 mm (4")	H3	3600 mm (12') - D	B	3600 mm (12')
C2	150 mm (6")	I3	6100 mm (20') - D & DC	C	6100 mm (20')
D2	200 mm (8")	J3	7300 mm (24') - D	D	7300 mm (24')
E2	300 mm (12")	K2	450 mm (18") - DR		
F2	450 mm (18")	L2	600 mm (24") - DR		
		M2	900 mm (36") - DR		

CODE	Fitting (only required for immersion "C")
A	Spring loaded 1/2" NPT
E	Non-spring loaded 1/2" NPT

Custom ranges available upon request

TE200	D	-	7	I3	-
-------	---	---	---	----	---

Greystone Energy Systems, Inc. reserves the right to make design modifications without prior notice.

**EXAMPLE:**  
Duct Average, 10 K Thermistor, 20' Copper

\* must use for high temperature applications over 400 C (752 F)

# ENCLOSURE DIMENSIONS:

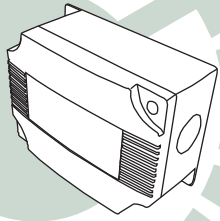

**ABS Enclosure**

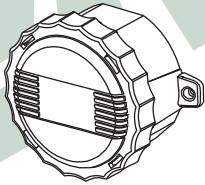
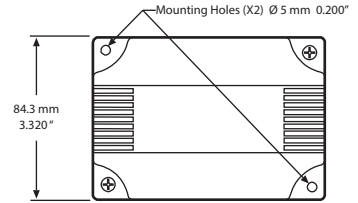
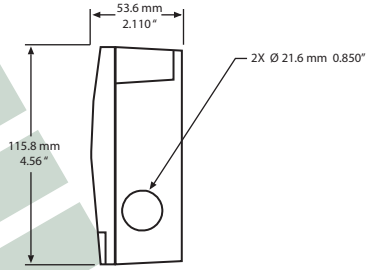

**Round ABS Enclosure (E)**

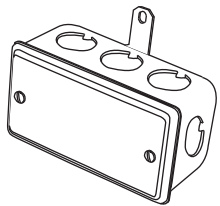
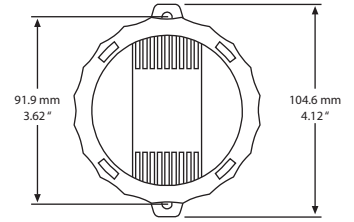
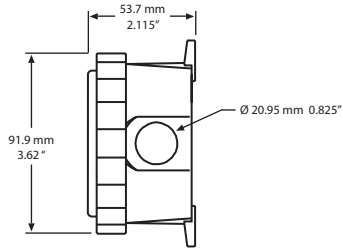

**Metal Enclosure (M)**

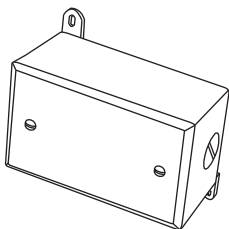
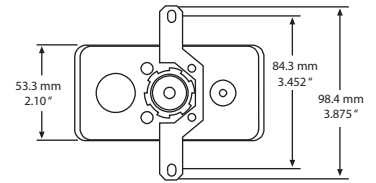
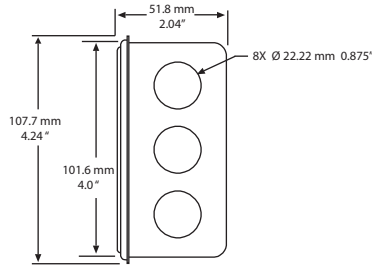

**Weatherproof Enclosure (W)**

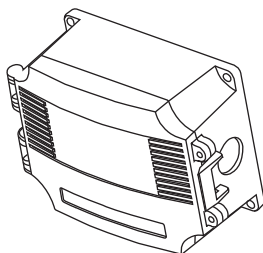
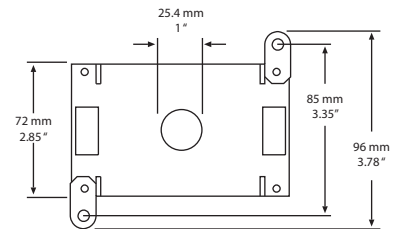
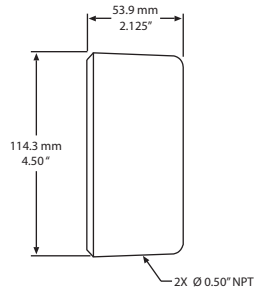

**ABS Hinged Weatherproof Enclosure (FX)**

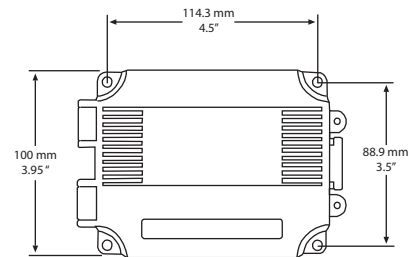
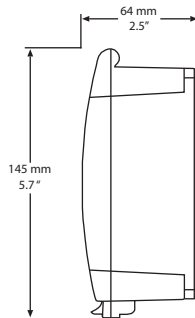

## ACCESSORIES:



**120-\*) Thermal Compound** – The 120- Thermal Conducting Compound is a zinc oxide-filled, dielectric, silicone oil-based compound that facilitates heat transfer by filling voids and gaps between mating surfaces. The operating temperature range is -40° to 200°C (-40° to 392°F). It is available in a 5 oz tube or 2 & 8 oz jars.



**DC-01) Duct collar** - The DC-01 is an adjustable collar for mounting the duct temperature sensor probes. It incorporates a foam backed mounting flange with 2 mounting holes. A compression type fitting accommodates a 1/4" probe and allows for an adjustable probe depth.



**CC-1G) Averaging probe clip** – The CC-1G is used to mount averaging sensors in duct applications. It can be used for probe diameters of 1/8", 1/4" and 3/8". The bracket provides support and a smooth arc for direction reversal allowing for criss-crossing the duct. It eliminates kinking of the sensor and damaging the probe.

A fixed 1/4" probe may also be mounted as part of the bracket design using the scored break-off. It is made out of tough UL94V Nylon and limits heat/cold conduction to the probe and has multiple mounting holes to make mounting quick and easy.



**TS17R-\*) Probe clamp** – The TS17R-\* is a zinc plated, rubber coated tube clamp that can be used to secure a temperature probe. It is available in several sizes to fit a wide variety of probes.



**GREYSTONE**  
ENERGY SYSTEMS INC

Greystone Energy Systems, Inc.  
150 English Drive, Moncton,  
New Brunswick, Canada E1E 4G7  
(506) 853-3057 Fax: (506) 853-6014  
North America: 1-800-561-5611  
e-mail: mail@greystoneenergy.com  
www.greystoneenergy.com

**RoHS**  
COMPLIANT



*Greystone Energy Systems Inc. is one of North America's largest ISO registered manufacturers of HVAC/R sensors and transmitters for Building Automation Management Systems.*

*We have conscientiously established a worldwide reputation as an industry leader by maintaining leading-edge design technology, prompt technical support, and a commitment to on-time deliveries. We take pride in our Quality Management System which is ISO 9001 certified, assuring our customers of consistent product reliability.*

GREYSTONE HAS AN **ISO 9001** REGISTERED QUALITY SYSTEM